



# Vehicle Cleaning Products

Longest Lasting and Most Reliable Pumps and Accessories



Product Quality, Reliability and Support You Expect

[www.zemarc.com](http://www.zemarc.com)

# Outruns, Outlasts and Outperforms the Competition.

## Maximize Uptime with Cat Pumps

You depend on your car wash to be up and running so you can protect your return on investment — and take care of your customers. That is why market leaders trust Cat Pumps to keep them open for business. Cutting corners by reducing quality does not pay in the long run. Buying a cheaper pump may sound like a good idea at first, but that low price can soon turn into higher costs when the pump goes down and your equipment is sitting idle.

For over 50 years, Cat Pumps has provided high-quality pumps and systems that are valued for long life and ease of maintenance. Our lowest cost-of-ownership and industry-leading reliability are two reasons why Cat Pumps is #1 pump in the industry — a market position we are proud to earn with every product we ship.

## Cat Pumps Benefits

### Technical Support

Cat Pumps is there when you need help. You can talk directly to a technician, visit our website for comprehensive data sheets, service manuals, and FAQs.

### Availability

Cat Pumps backs its quality products with unparalleled delivery and service. Parts and pumps are on the shelf for 24-hour shipping. Our highly-trained distributor network provides expert sales, field service and support at the level you expect from a world product leader.

### Easy and Minimal Maintenance

Our superior design, including our proprietary seal and valve kits, makes maintenance easy. Customers in every market tell us how seldom they need to service Cat Pumps equipment.

### Cat Pumps Advantage

- Higher productivity and less downtime
- Fewer repairs and less maintenance costs
- Greater confidence in equipment performance
- Service parts and pumps stocked for 24-hour shipping
- Excellent customer and technical support

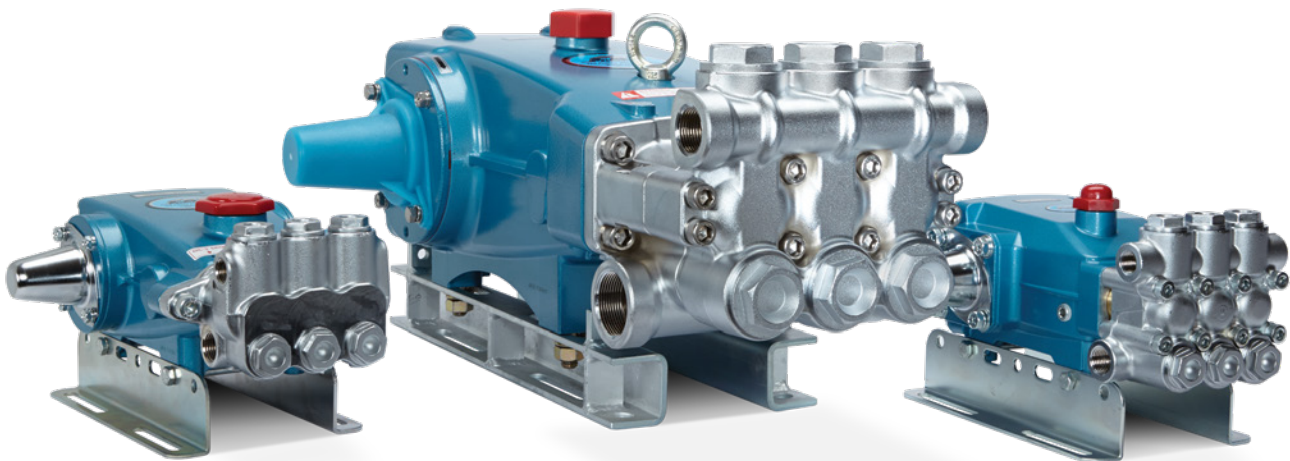

*The most popular car wash pumps in North America. Cat Pumps is #1 for a reason: dependability you can count on.*

# Built for Dependable Performance

Quality is evident in every detail of Cat Pumps products — built to be the longest-lasting and most dependable available.

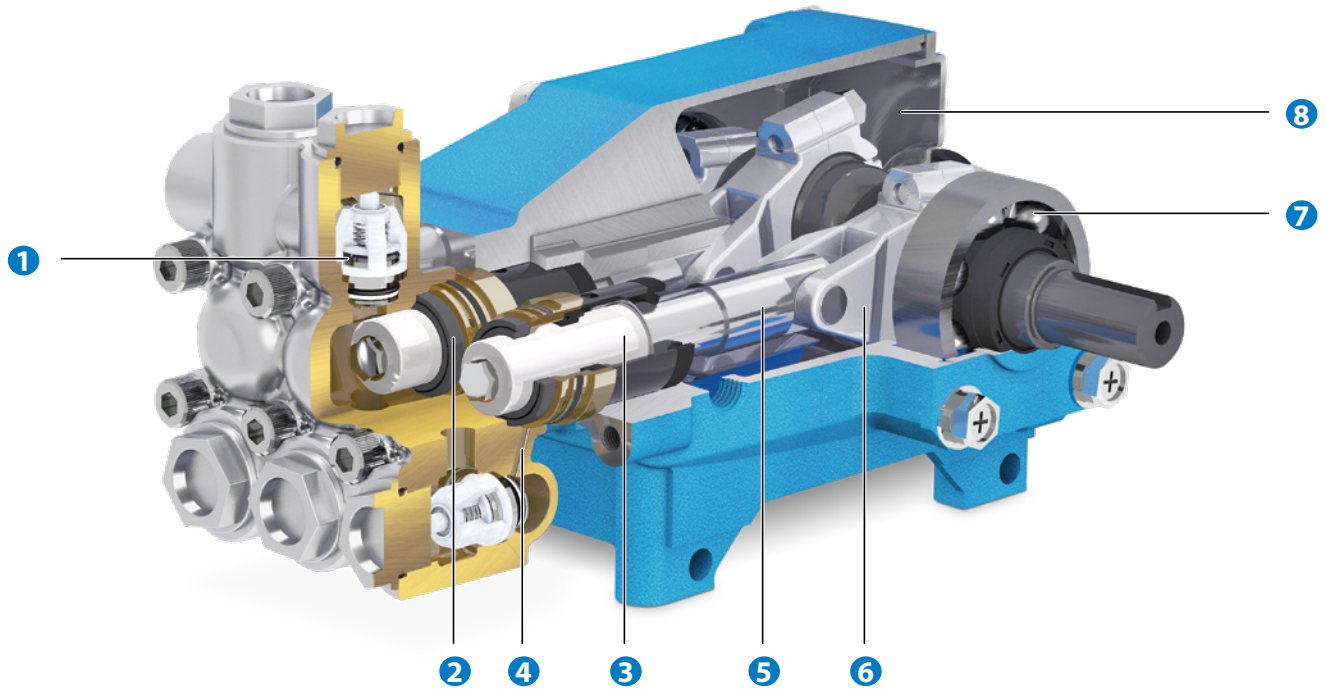

- 1 Stainless steel valves, seats and springs provide corrosion-resistance, positive seating and long life.
- 2 Specially formulated, Cat Pumps exclusive high-pressure seals offer unmatched performance and seal life.
- 3 Precision-polished, solid ceramic plungers provide maximum resistance to corrosion and abrasion, extending seal life.
- 4 100% wet seal design adds to service life by allowing pumped fluids to cool and lubricate the elastomers on both sides.
- 5 The high-strength stainless steel plunger rods have a 360° supported crosshead providing uncompromising plunger rod alignment.
- 6 Matched oversized connecting rods are made of high-strength material with exceptional bearing quality.
- 7 Oversized ball bearings or tapered roller bearings provide extended bearing life.
- 8 High-strength, lightweight die cast aluminum crankcase with splash oil design allows operation at speeds as low as 100 rpm.

## Applications

- Self-Serve
- Automatic
- Prep Unit
- Detailing
- Rocker Panel Blasting
- Under Carriage Wash
- Truck Wash
- Heavy Equipment Wash
- High Pressure Rinse
- High Pressure Wash
- Wheel Blasting



# Plunger Pumps, Direct Drive, Bell Housing

Bell housing and flex coupler offer direct drive option for select models

Pump Model	Maximum Flow		Maximum Pressure		Pump rpm	Power*	
	gpm	lpm	psi	bar		hp	kW
340, 340B	4	15	1800	124	1725	5.0	3.7
5CP2140WCS, 5CP2140BCS	4	15	2500	172	1725	6.9	5.1
350, 350B	5	19	1500	103	1725	5.1	3.9
5CP2150W, 5CP2150B	5	19	2000	138	1725	6.9	5.1
5CP6120	7.4	28	1200	83	1725	6.1	4.6
56	8	30	2500	172	1760	13.7	10.3
5CP6180CSS	8.2	31	1500	103	1750	8.4	6.3
5CP6190	10	38	1200	83	1750	8.2	6.2
7CP6110CS	10.5	40	2000	138	1750	14.4	10.8

\* hp and kW calculated at maximum flow and pressure.

\* Brake Horse Power (BHP) = gpm x psi / 1460

\* kW = BHP \* 0.75

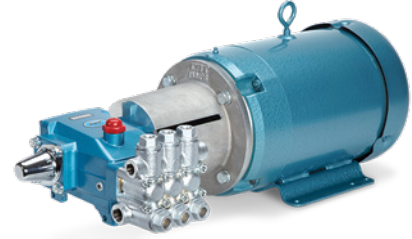

Direct Drive Model 5CP6190BH73

## Direct-Drive Mounting Components

Pump Model	Motor Frame	Bell Housing Assembly	Flex Coupling Assembly
340, 340B, 350, 350B	56C-145TC	76056.5FR	8260
	182/184TC	76184.5FR	8230
	213/215TC	76215.5FR	8275
5CP Series	143/145TC	76056.5CP	8260
	182/184TC	76184.5CP	8230
	213/215TC	76215.5CP	8275
	254/256TC	76256.5CP	8217
56	182/184TC	76184.7FR	8370
	213/215TC	76215.7FR	8375
	254/256TC	76256.7FR	8380
7CP6110CS	182/184TC	76184.7CP	8370
	213/215TC	76215.7CP	8375
	254/256TC	76256.7CP	8380



Bell Housings and Flexible Couplings

Note: Contact Cat Pumps for complete motorized pump units (pump, motor, bell housing & flexible coupling)

## Proven Dependability with Reclaim Water

For decades, thousands of Cat Pumps systems have been reliably used with reclaim systems, pumping fluids with particle sizes to 50 micron. Car wash reclaim systems typically operate in the 5 – 50 micron range, with the majority running 5 – 25 micron range. The water quality and type of particulate does have a direct effect on pump life. As particle size increases, there is a potential decrease in pump life. Consequently, we recommend the following specifications to maintain performance and achieve maximum pump life:

- Particle size - not to exceed 50 micron
- TSS - not to exceed 50 ppm
- pH - maintained between 5 and 9
- Sediment pits cleaned regularly
- Reclaim filtration system must be operated and maintained according to requirements provided by manufacturer

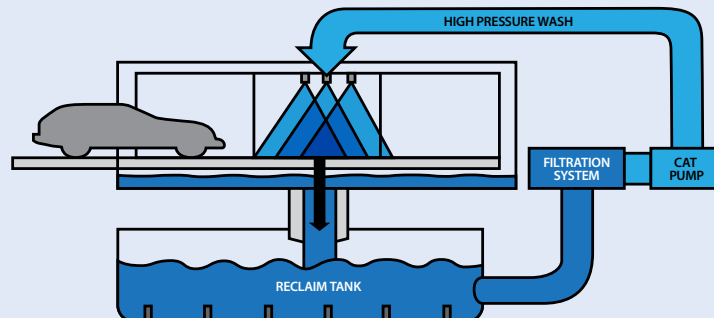

## Plunger Pumps, Belt Drive

Belt drive pumps are the most flexible and most commonly used. This flexibility allows you to size pulleys to precise rpm for the desired flow.

Pump Model	Maximum Flow		Maximum Pressure		Pump rpm	Power*	
	gpm	lpm	psi	bar		hp	kW
310, 310B, 310BQ	4	15	2200	152	950	6.0	4.5
5CP2120W,	4	15	2500	172	950	6.8	5.1
5CP2120B	5	19	2000	138	1188	6.8	5.1
530	5	19	2500	172	1100	8.6	6.4
5CP6190	8	30	1450	100	1450	7.9	6.0
5CP6180CSS	8.2	31	1500	103	1750	8.4	6.3
1050	10	38	2200	152	958	15.1	11.3
7CP6170	11	41.6	2000	138	1450	15.1	11.3
1050	12	45.4	1800	124	1150	14.8	11.1
1530	15.6	59	1500	103	1450	16.0	12.0
1540E	18	68	1200	83	1100	14.8	11.1
2510	20	76.0	2000	138	1450	27.4	20.5
2530	25	95.0	1000	69	1025	17.1	12.8
3535	36	136	1200	83	800	29.6	22.2
3545	45	170	1000	69	765	30.8	23.1
6760	60	227	1200	83	520	49.3	37.0
6775	75	284	1200	83	650	61.6	46.2

\* hp and kW calculated at maximum flow and pressure.

\* Brake Horse Power (BHP) = gpm x psi / 1460

\* kW = BHP \* 0.75

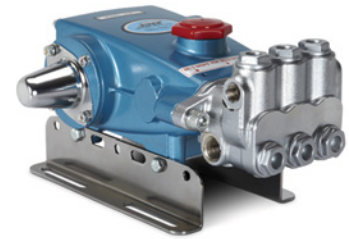

Model 310

## Piston Pumps, Belt Drive

Piston Pumps offer a unique "Uniflow Design" which is capable of up to 19 ft of suction head.

Pump Model	Maximum Flow		Maximum Pressure		Pump rpm	Power*	
	gpm	lpm	psi	bar		hp	kW
430	5	19	1000	69	1040	3.4	2.6
623	6	23	1200	83	850	4.9	3.7
820	10	38	1000	69	940	6.8	5.1
390	12	45.4	600	41.4	1200	4.9	3.7
1010	13	49	700	48	900	6.2	4.7
6040	40	151	1500	103	500	41.1	30.8
6020	60	227	1000	69	500	41.1	30.8

\* hp and kW calculated at maximum flow and pressure.

\* Brake Horse Power (BHP) = gpm x psi / 1460

\* kW = BHP \* 0.75



Model 820

## "B" Series Washout Resistant Manifolds

The "B" Series was developed for car wash applications where persistent manifold washout problems exist. Field proven in the most demanding car washes for significant improvement in pump service life.

- Superior corrosion-resistant alloy
- Chrome-plated finish provides wear and discoloration protection
- Lifetime warranty against washout and freezing in self-service or prep unit car wash applications. See Cat Pumps Limited Warranty Statement.

Available Models: 310B, 340B, 350B, 5CP2120B, 5CP2140BCS, 5CP2150B

## New "Q" Series Quiet Option

The new "Q" option is designed for applications where a reduced sound level is desirable. Through the use of special materials, "Q" series pumps produce 67% less acoustic energy which results in a significant perceptible noise reduction. The "Q" option is currently available in the model 310BQ. Contact Cat Pumps for more information.

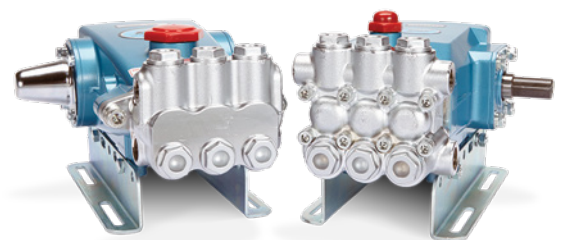

Models 310B and 5CP2120B

# TECH TIP

Due to the design of positive displacement pumps, small pressure spikes are caused during each rotation. In certain operations, these spikes can cause accelerated wear or damage to the pump or downstream components. The installation of a pulsation dampener is your best safeguard against premature wear.

## Model 1530 w/o pulsation dampener

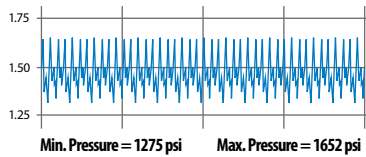

## Model 1530 w/ pulsation dampener

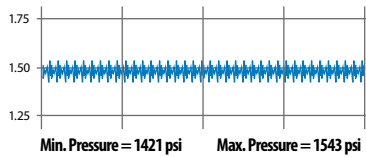

### Pulsation Dampener Benefits:

- Produces smooth, consistent flow
- Protects downstream components (e.g., regulator, unloader, relief valve)
- Reduces water hammer
- Improved performance at low rpm

## Pulsation Dampeners

316 SS Fitting with Carbon Steel Body, Sealed, Fixed Precharge

Model	Maximum Flow		Pressure Range		Bladder Material	Volume Cubic Inches	Precharge psi
	gpm	lpm	psi	bar			
6026	15	57	300 - 600	20 - 41	NBR	10	250
6028	15	57	600 - 1000	41 - 69	NBR	10	450

316 SS Fitting with Carbon Steel Body, Adjustable Precharge, Rechargeable

Model	Maximum Flow		Pressure Range		Bladder Material	Volume Cubic Inches	Precharge psi
	gpm	lpm	psi	bar			
6029	15	57	100 - 3000	6.9 - 207	NBR	10	450
6018	40	151	100 - 3000	6.9 - 207	NBR	45	450
6012	70	265	100 - 1500	6.9 - 103	NBR	120	450

## Pressure Gauges

Glycerine filled for consistent and accurate readings

Model	Maximum Pressure		Fitting	Port
	psi	bar		
6086	1500	103	Brass	1/4" NPT(M)
6088	3000	207	Brass	1/4" NPT(M)
6089	6000	415	Brass	1/4" NPT(M)

## Inlet Filters

Clear Nylon Body

Model	Suction/ Pressurized Flow		Screen		Ports	
	gpm	lpm	Mesh	Material	Inlet	Discharge
7104.4	6/10	23/38	80	S	1/2" NPT(F)	1/2" NPT(F)
7105.5	15/20	57/76	80	S	3/4" NPT(F)	3/4" NPT(F)
7106.6	20/25	76/95	80	S	1" NPT(F)	1" NPT(F)
7107.7	35/50	133/189	80	S	1-1/4" NPT(F)	1-1/4" NPT(F)
7108.8	60/75	227/284	80	S	1-1/2" NPT(F)	1-1/2" NPT(F)

## Pressure Switches

Stainless Steel - NPT ports

Model	Maximum Pressure psi	Maximum Pressure bar	Engaging Pressure		Voltage Range	Maximum amp	Inlet Port
			psi	bar			
31615	3650	250	215	15	12 - 250	6	1/4" NPT(M)
31625	3650	250	360	25	12 - 250	6	1/4" NPT(M)
31640	3650	250	580	40	12 - 250	6	1/4" NPT(M)

## Shut-off and Weep Guns

Brass (internal body)

Model	Maximum Flow		Maximum Pressure		Type	Ports	
	gpm	lpm	psi	bar		Inlet	Discharge
76165	8	30	4000	275	Shut-off	3/8" NPT(F)	1/4" NPT(F)
76168	8	30	4000	275	Weep	3/8" NPT(F)	1/4" NPT(F)
36140	10.5	40	5000	345	Shut-off	3/8" NPT(F)	1/4" NPT(F)
36141	10.5	40	5000	345	Weep	3/8" NPT(F)	1/4" NPT(F)
39415	32	121	1750	120	Shut-off	1/2" BSP(F)	1/2" BSP(F)
39420	53	200	2900	200	Shut-off	3/4" BSP(F)	1/2" BSP(F)

## Pressure Regulators

Primary pressure control

Model	Flow Range		Pressure Range	
	gpm	lpm	psi	bar
7001	0.5 - 5	1.9 - 19	100 - 1000	6.9 - 69
7002	0.5 - 5	1.9 - 19	500 - 2000	35 - 138
7003	0.5 - 5	1.9 - 19	1500 - 3000	103 - 207
7011	1 - 10	3.8 - 38	100 - 1000	6.9 - 69
7012	1 - 10	3.8 - 38	500 - 2000	35 - 138
7013	1 - 10	3.8 - 38	1500 - 3000	103 - 207
7021	2.5 - 25	9.5 - 95	100 - 1000	6.9 - 69
7022	2.5 - 25	9.5 - 95	500 - 2000	35 - 138
7023	2.5 - 25	9.5 - 95	1500 - 3000	103 - 207
7031	3.5 - 35	13.2 - 132	250 - 1000	18 - 69
7032	3.5 - 35	13.2 - 132	1000 - 2000	69 - 138
7033	3.5 - 35	13.2 - 132	1500 - 3000	103 - 207
7375	10 - 75	38 - 284	100 - 1000	6.9 - 69
7376	10 - 75	38 - 284	500 - 2000	35 - 138

## Pressure Unloaders

Primary pressure control

Model	Flow Range		Pressure Range	
	gpm	lpm	psi	bar
7583	0.5 - 8	1.9 - 30	250 - 2000	17 - 138
7620	0.5 - 8	1.9 - 30	100 - 3200	6.9 - 220
7693	2.5 - 10.5	9.5 - 40	230 - 2300	16 - 60
7694	2.5 - 10.5	9.5 - 40	400 - 4050	28 - 280
7537	1 - 21	3.8 - 80	230 - 2600	15.8 - 180
7542	1 - 21	3.8 - 80	800 - 4000	55 - 275
7590	10 - 52	39 - 197	400 - 2175	30 - 150
7593	10 - 52	39 - 197	750 - 4050	52 - 279
9950	50 - 120	189 - 450	100 - 2900	6.9 - 200

## Relief Valves

Primary or Secondary Pressure Control

Model	Maximum Flow		Pressure Range	
	gpm	lpm	psi	bar
7500S	6	23	100 - 2000	6.9 - 138
7620.100	8.0	30	100 - 3200	6.9 - 220
7630.100	10	40	400 - 5100	28 - 350
7694.100	10.5	40	400 - 4050	28 - 280
7542.100	21	80	800 - 4000	55 - 275
7595	53	200	260 - 2600	18 - 180
9950.100	120	456	100 - 2900	6.9 - 200

## Pop-off Valves

Secondary Pressure Control

Model	Maximum Flow		Pressure Range	
	gpm	lpm	psi	bar
33960	6	23	300 - 1500	20 - 103
30961	6	23	1000 - 3000	69 - 207
33962	6	23	1000 - 4000	69 - 275
9940	25	95	1000 - 4000	69 - 275

## TECH TIP

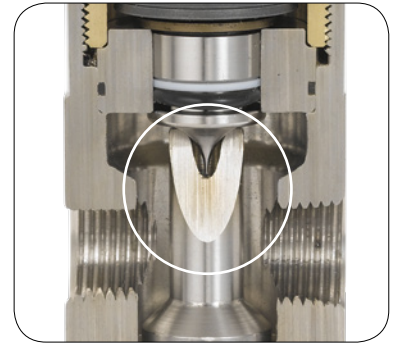

7001-7033, 7375-76 Series Regulators exclusively from Cat Pumps feature conical design delivering unmatched performance and life.

### Features:

- Conical design lowers minimum bypass flow from 10% - 5%, optimizing system performance
- Virtually eliminates cavitation effects across piston and seat, significantly extending life
- Compact in-line plumbing
- Low-pressure override provides smooth and stable operation without chatter.

## CHECK OUT

### Regulator vs Unloader Valve Product Comparison



This product comparison video from Cat Pumps offers an in-depth look at one of our most common inquiries – the difference between a pressure regulator and pressure regulating unloader valve.

[www.catpumps.com/youtube](http://www.catpumps.com/youtube)



## ABOUT CAT PUMPS

### Proven Quality, Customer Focused

Cat Pumps is the world leader in the design, manufacture and marketing of the most dependable high-pressure positive displacement reciprocating triplex pumps and systems in the market. Our mission to exceed customer expectations for quality, reliability, availability, delivery, technical expertise and aftermarket support to assure the best value in all the industries served.

## ZEMARC LOCATIONS

### Los Angeles – Headquarters

6431 Flotilla Street  
Los Angeles, CA 90040

P: 323.721.5598

F: 323.722.2220

### Hayward – Regional Office

1801 Addison Way  
Hayward, CA 94544

P: 510.783.3964

F: 510.783.1443

### Fresno – Regional Office

3510 E. Church Avenue  
Fresno, CA 93725

P: 559.264.2009

F: 559.268.2361

### Oxnard – Regional Office

2960 Los Olivos  
Oxnard, CA 93036

P: 805.973.5900

F: 805.973.5919

### Chula Vista – Regional Office

1128 Bay Blvd., Ste D  
Chula Vista, CA 91911

P: 760.471.0901

F: 760.471.0902

Contact Zemarc Corporation for more information at [sales@zemarc.com](mailto:sales@zemarc.com) or [www.zemarc.com/catpumps](http://www.zemarc.com/catpumps)